

OPUS HE WMC 24-1500 F  
OPUS HE WMC 48-2000 F  
OPUS HE WMC 60-2000 F  
OPUS HE WMC 110-2000 F  
OPUS HE WMC 125-2000 F  
OPUS HE WMC 220-2000 F



## Product Description

OPUS HE WMC Wall Mounted Chargers are robust and free convection cooled backup power solutions. Together with external battery bank it provides reliable and cost-effective uninterrupted DC supply for critical infrastructure applications such as transmission and distribution substations, process industries, railway signalling and telecommunications.

OPUS HE DC power systems consist of MHE rectifiers, VIDi+ controllers, Connections for mains and battery and load distribution MCB. System is configurable to meet requirements of the application. On top of 12 configurable relay alarms, system can be remotely monitored via modern communication protocols such as Ethernet TCP/IP, Modbus TCP/IP, SCADA IEC61850, SNMP and RS-232.

WMC Wall Mounted Charger product line consists of MHE rectifier, VIDi+ I/O controller, MCB protections for mains, load and battery packaged in wall mounted IP21 enclosure. Charger delivers 2kW output power at 48V, 60V, 110V, 125V and 220 V battery systems and 1.5kW at 24 V systems.

## Features

- Efficiency up to 97%
- Convection cooling – no fans
- Outputs 24, 48, 60, 110, 125, 220 VDC
- Easy installation
- Battery MCB for one string
- Mains switch and MCB, Load MCB
- Configurable A+B double charger set-up
- VIDi+ I/O controller, local and remote interfaces  
4 x relays, Ethernet, Modbus, SNMP, RS-232
- Options:  
Battery LVD, battery temp.sensor, SCADA IEC61850
- Safety:  
EN61439-1, EN61439-2  
Low voltage switchgear controlgear assemblies
- EMC:  
Cabinet: EN61439-1, EN61439-2  
Rectifiers: EN 61000-6-1 / -2 / -3 / -4 / -5  
ETSI EN 300386 (48/60V)

# Technical Specifications

General construction	
Cooling	Natural convection
Protection	IP21
Controller user interface	Display and local control in front door & web interface
Cabling	Bottom entry
Colour	RAL 7024
Dimensions & weight	H 520 mm x W 400 mm x D 200 mm 15kg

Environment and standards	
Temp. range	-25 ... +60°C, see derating, Start-up at -40°C
Humidity max	95% relative humidity, non-condensing
Altitude	Max 3km, full power up to 2km above sea level Derating 2% per 100 m between 2-3km
Safety	EN61439-1, EN61439-2
EMC	EN61439-1, EN61439-2 EN61000-6-1 / -2 / -3 / -4 Generic EN61000-6-5 Utility, surge level 2 ETSI EN 300386 (48/60V)

AC Input	
AC connection	L + N + PE (option 2 x L + PE)
Nominal input	200-250 VAC 50/60Hz
Input range	Max range: 85 – 300 VAC Rated full power range: 180 – 275 VAC See derating curves below, 1200W per rectifier at 120VAC Temporary high voltage range 275 - 300VAC, continuous supply not recommended
Input frequency	Rated 45 - 66 Hz, reduced power at 35 - 45 Hz. Shut down at 35 Hz
Main Switch	16A, 2-pole
Rectifier input protection	MCB C16A 1-pole
	<b>24V</b>   <b>48V</b>   <b>60V</b>   <b>110V</b>   <b>125V</b>   <b>220V</b>
Nominal current	8A @ 220V   11A @ 220VAC
Maximum current	12,5A @ 85-130V   12,5A @ 85-180VAC
Recommended mains fuse	25 A

DC Output	24V	48V	60V	110V	125V	220V
Grounding	2-pole, floating					
Nominal voltage	24 VDC	48 VDC	60 VDC	108 VDC	120 VDC	216 VDC
Voltage factory setting, 2.27vpd	27.24 VDC	54.48 VDC	68.10 VDC	122.58 VDC	136.20 VDC	245.16 VDC
Voltage range	21-33 VDC	42-59 VDC	51-72 VDC	90-150 VDC	100-160 VDC	178-280 VDC
Static voltage regulation	± 1 % @ load terminals (load, line, temp)					
Max current	62.5A @ 24V	41.7A @ 48V	33.3A @ 60V	18.5A @ 108V	16.7A @ 120V	9.3A @ 216V
Max Power	1.5kW	2kW	2kW	2kW	2kW	2kW
Rectifier module output protection, 1-pole	MCB C63A	MCB C50A	MCB C40A	MCB C20A	MCB C20A	MCB C10A
Battery fuse, 2-pole + aux	MCB D100A	MCB D80A	MCB D63A	MCB D63A	MCB D63A	MCB D63A
Load fuse, 2-pole + aux	MCB C63A	MCB C50A	MCB C40A	MCB C20A	MCB C20A	MCB C10A

Connection terminals	
Mains terminal	Terminal blocks 2.5 mm <sup>2</sup> , L + N (L) + PE
Battery	Battery MCB FB1 Screw terminals
Load	Load MCB FL1 Screw terminals
A+B parallel supply	Parallel supply FP1 MCB screw terminals
Alarms & Inputs	Configurable relay alarms 4 pcs, Spring terminals 0.75mm <sup>2</sup> ... 1.5mm <sup>2</sup> cable Configurable external alarm/temp. inputs 2 pcs, Spring terminals 0.75mm <sup>2</sup> ... 1.5mm <sup>2</sup> cable

## Derating curves

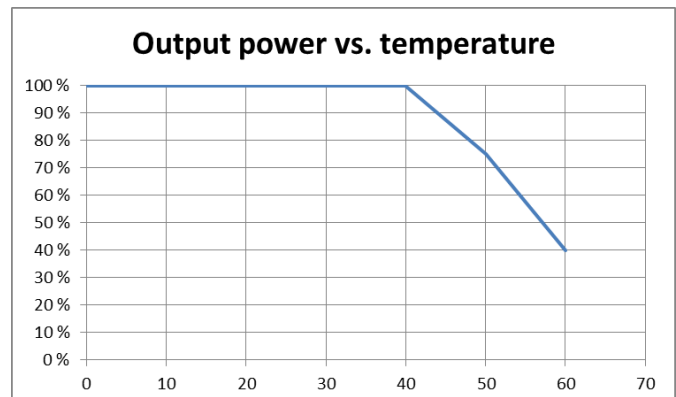
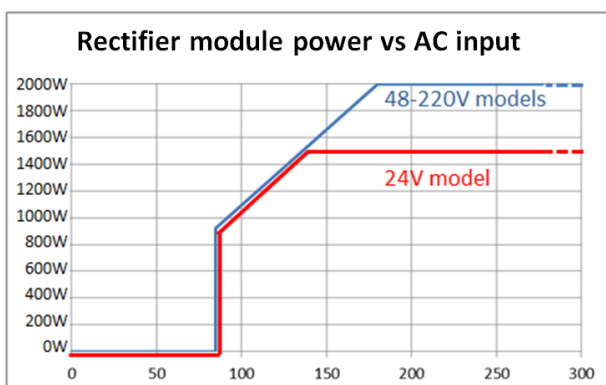

## Layout drawing

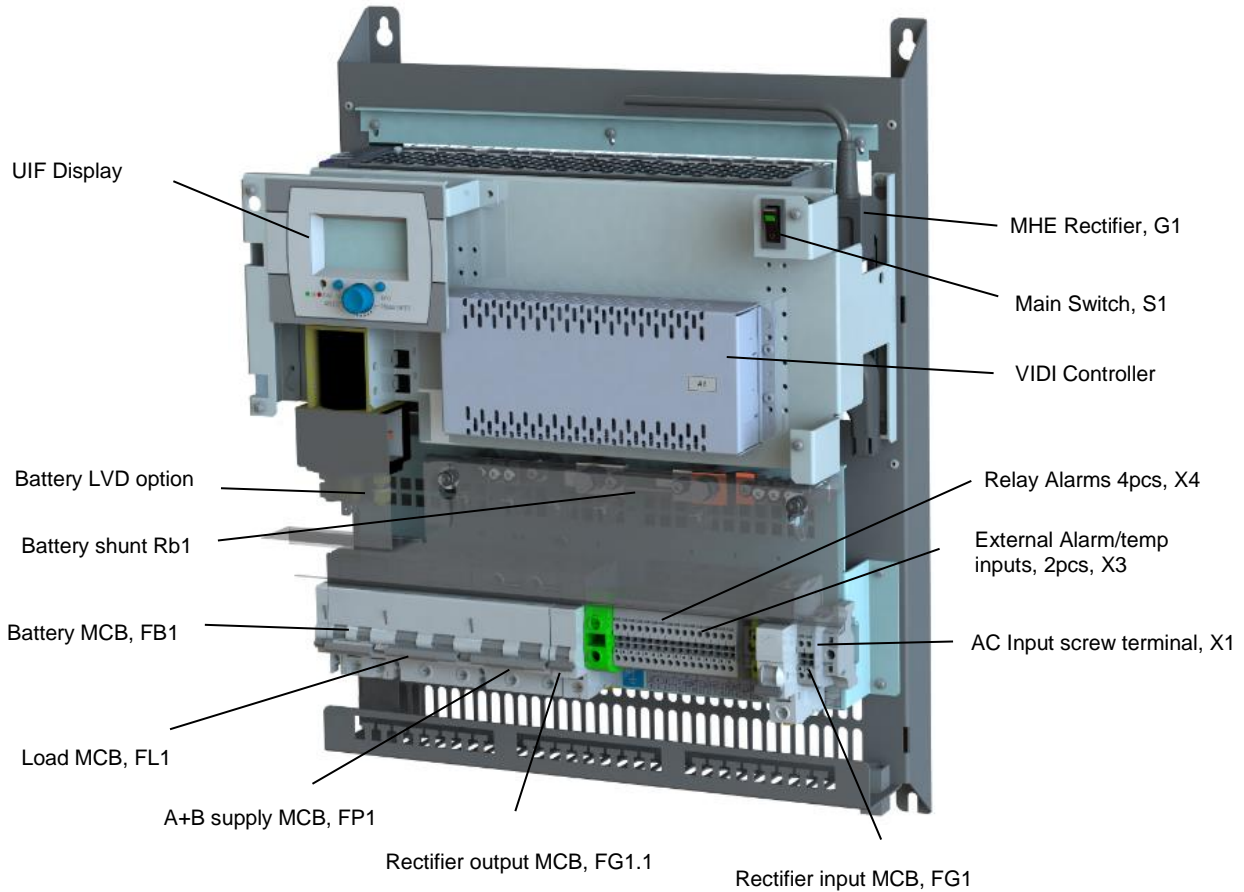

## Block Diagram

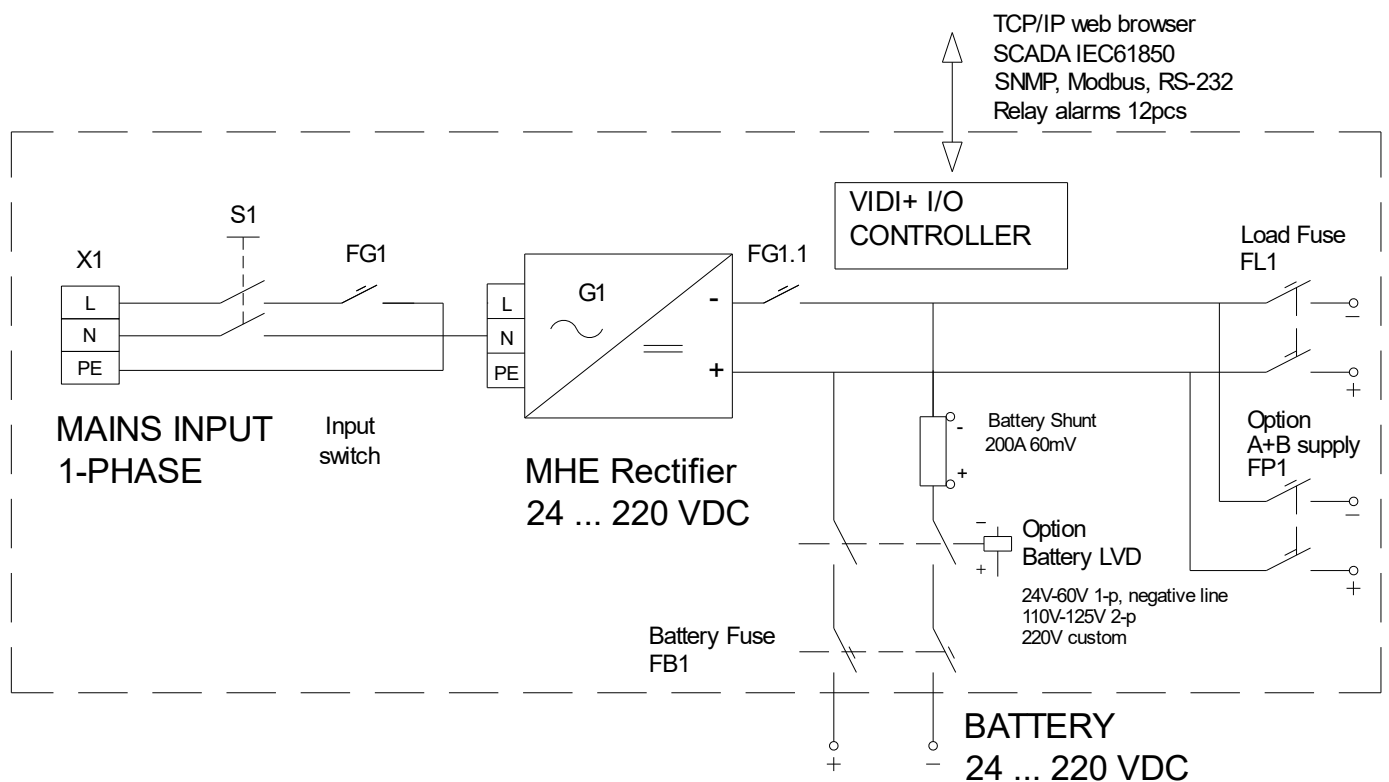

# Application Note: A + B double systems & external distribution panels

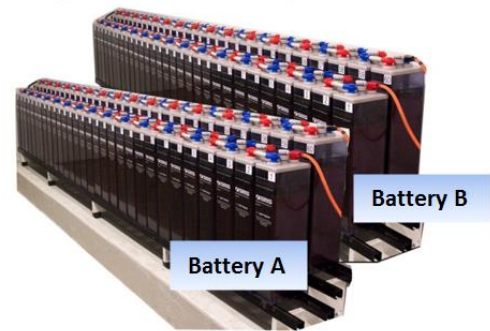
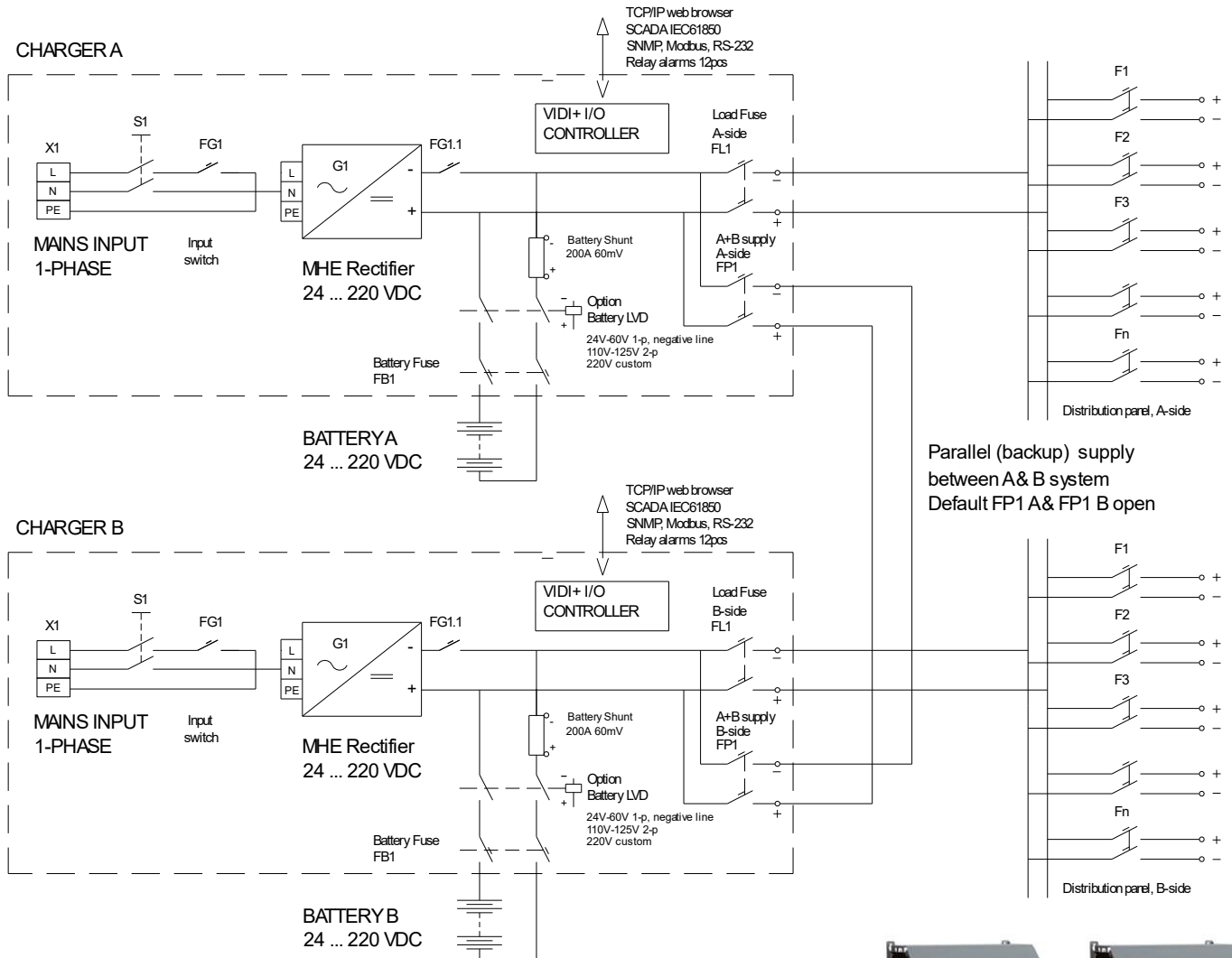

## Order Information

Systems, Description	Order number	Voltage / Current
OPUS HE WMC 24-1500 F	9220X0011257	24VDC / 62.5A – 187.5A
OPUS HE WMC 48-2000 F	9220X0011286	48VDC / 41.7A – 125A
OPUS HE WMC 60-2000 F	9220X0011287	60VDC / 33.3A – 100A
OPUS HE WMC 110-2000 F	9220X0011269	110V / 18.5A – 55.5A
OPUS HE WMC 125-2000 F	9220X0011270	125V / 16.7A – 50A
OPUS HE WMC 220-2000 F	9220X0011276	220V / 9.3A – 27.8A

Configurable features	Order number
Temperature Sensor	94M268
BLVD 24V 100A 1-P OPUS WMC/WRS	8320X0014246
BLVD 48/60V 100A 1-P OPUS WMC/WRS	8320X0014337
BLVD 110/125V 100A 2-P OPUS WMC/WRS	8320X0015456
Parallel supply, A+B system, MCB 63A 2-p+aux	832X015908
Parallel supply, A+B system, MCB 125A 2-p+aux	8320X0015264